

ABA ORIGINAL



- ① Extra strong one-piece pressed housing
- ② Rolled-up band edges
- ③ Smooth band underside

There is only one Original

ABA Original clamps feature an extra strong one-piece pressed housing, rolled-up band edges and a smooth band underside that protects the hose. ABA Original – the trouble-free clamp with high tightening force and high breaking torque.

Advantages at a glance

- High clamping force
- High breaking torque
- Protection of the hose thanks to the smooth band underside
- Every clamp is date stamped for traceability

Typical applications

- Machine building
- Chemical industry
- Irrigation systems
- Railway
- Agricultural machines
- Building machines
- Marine

Materials



ABA stainless steel clamps are the natural choice for applications where corrosion resistance is required.

ABA Original Aluzink S20

- The band is made of Aluzink for added corrosion resistance, this gives three times the protection offered by conventional galvanized steel

ABA Original Stainless S40

- All parts are made of SS 2333/AISI 304 stainless steel

ABA Original Acid-Resistant S50

- All parts are made of SS 2343/AISI 316 stainless steel
- Natural choice for applications where premium corrosion resistance is required

Dimensions

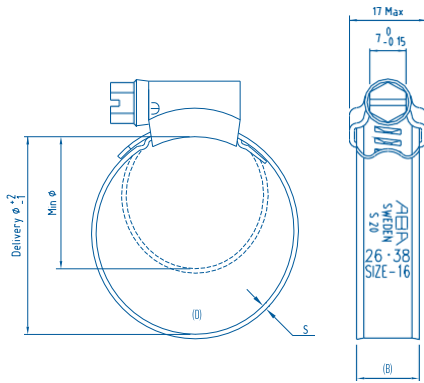

Specifications

ABA ORIGINAL 12 MM						
Width	Clamping ranges	Clamping ranges	Thickness	S20	S40	S50
(B mm)	(D mm)	(D in.)	(S mm)	Product No.	Product No.	Product No.
12	15-24	9/16-15/16	0.8	0813 4001 020	0813 4003 020	0813 4034 020
	19-28	3/4-1 1/8	0.8	0813 4001 024	0813 4003 024	0813 4034 024
	22-32	7/8-1 1/4	0.8	0813 4001 027	0813 4003 027	0813 4034 027
	26-38	1-1 1/2	0.8	0813 4001 032	0813 4003 032	0813 4034 032
	32-44	1 1/4-2 3/4	0.8*	0813 4001 038	0813 4003 038	0813 4034 038
	38-50	1 1/2-2	0.8*	0813 4001 044	0813 4003 044	0813 4034 044
	44-56	1 3/4-2 3/16	0.8*	0813 4001 050	0813 4003 050	0813 4034 050
	50-65	2-2 9/16	0.8*	0813 4001 058	0813 4003 058	0813 4034 058
	58-75	2 1/4-2 15/16	0.8*	0813 4001 067	0813 4003 067	0813 4034 067
	68-85	2 11/16-3 3/8	0.8*	0813 4001 077	0813 4003 077	0813 4034 077
	77-95	3-3 3/4	0.8*	0813 4001 086	0813 4003 086	0813 4034 086
	87-112	3 7/16-4 7/16	0.8*	0813 4001 100	0813 4003 100	0813 4034 100
	104-138	4 1/16-5 7/16	0.8*	0813 4001 121	0813 4003 121	0813 4034 121
	130-165	5 1/8-6 1/2	0.8*	0813 4001 148	0813 4003 148	0813 4034 148
	150-180	5 15/16-7 1/16	0.8*	0813 4001 165	0813 4003 165	0813 4034 165
	175-205	6 7/8-8 1/16	0.8*	0813 4001 190	0813 4003 190	0813 4034 190
	200-231	7 7/8-9 1/16	0.8*	0813 4001 216	0813 4003 216	0813 4034 216
	226-256	8 7/8-10 1/16	0.8*	0813 4001 241	0813 4003 241	0813 4034 241
	251-282	9 7/8-11 1/8	0.8*	0813 4001 267	0813 4003 267	0813 4034 267
	277-307	10 15/16-12 1/16	0.8*	0813 4001 292	0813 4003 292	0813 4034 292

* 1.0 for S20