

TriaAir fordelerboks

Ø160 nippel – 5 muffler Ø75 L1300 - venstre

Varenr. MC75B05160-2

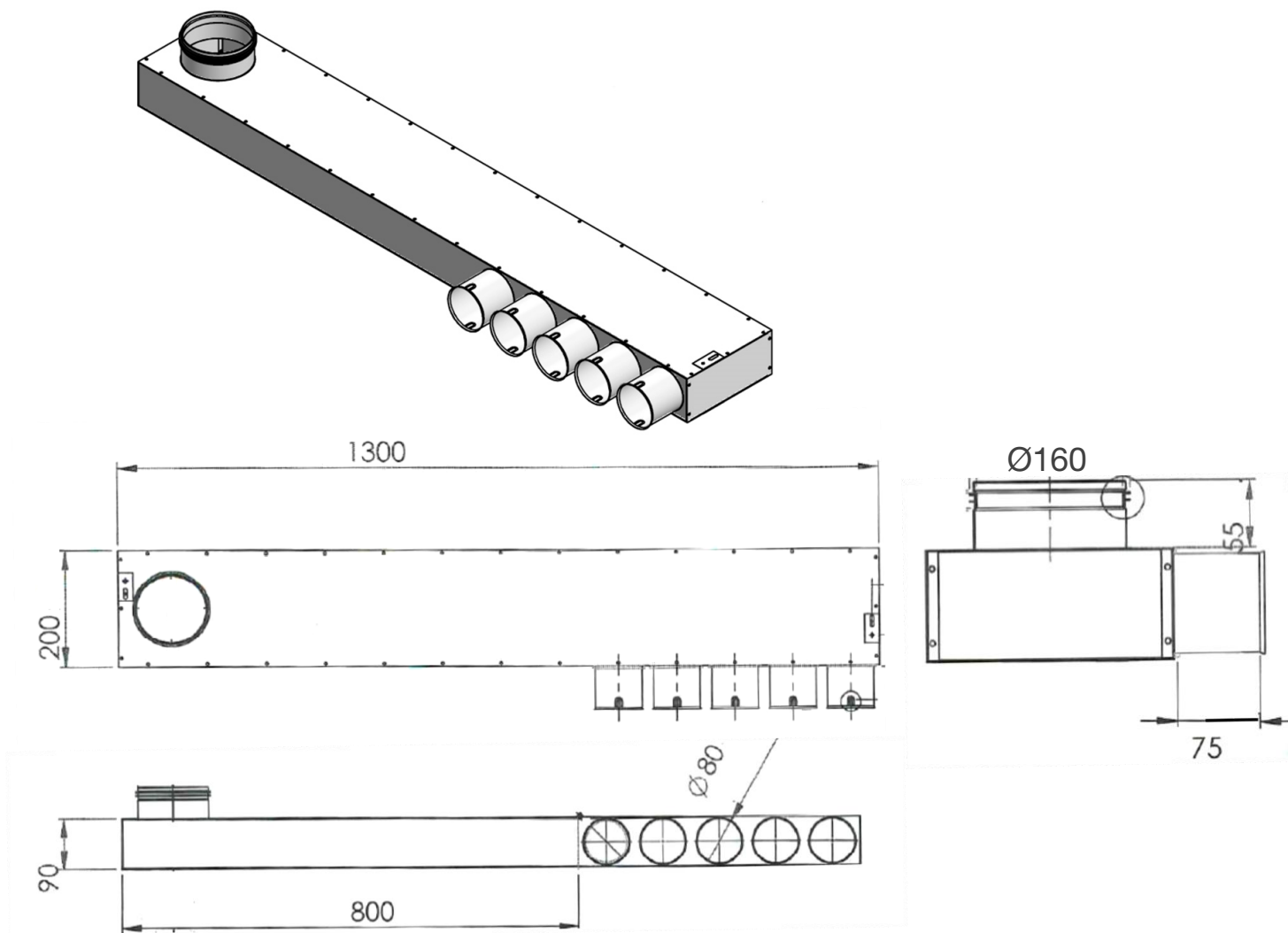

Flowdiagram

MC75B05160-2	
Flow Rate [m ³ /h]	Resistance [Pa]
40	0,7
60	1,1
80	1,4
110	2,7

