

Tekniske data

NOTUS1 HV m/Entalpi, 415 m³/t



Digitalt display med touch skærm (trådløst)



App

Varenr.: EPP000180-ET, APP styring / Entalpiveksler
Vægt: 20 kg
Materiale: EPP / Metal

Ventilationsanlæg med høj varmegenvinding og fugtstyring.

Lille, let og kompakt designet decentralt anlæg - vægt 20 kg.

Plug-and-Play.

Produkt webside for yderligere info.



Scan koden med dit mobilkamera

Tekniske data

NOTUS1 HV m/Entalpi, 415 m³/t

Flowdiagram

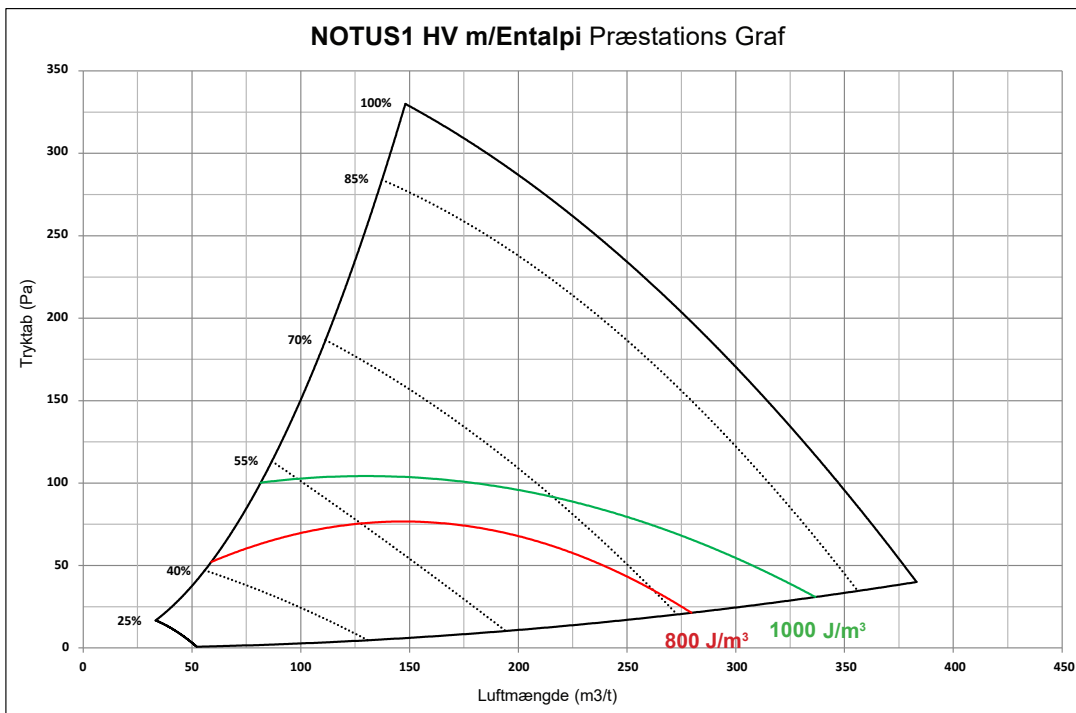

Temperaturvirkningsgrad

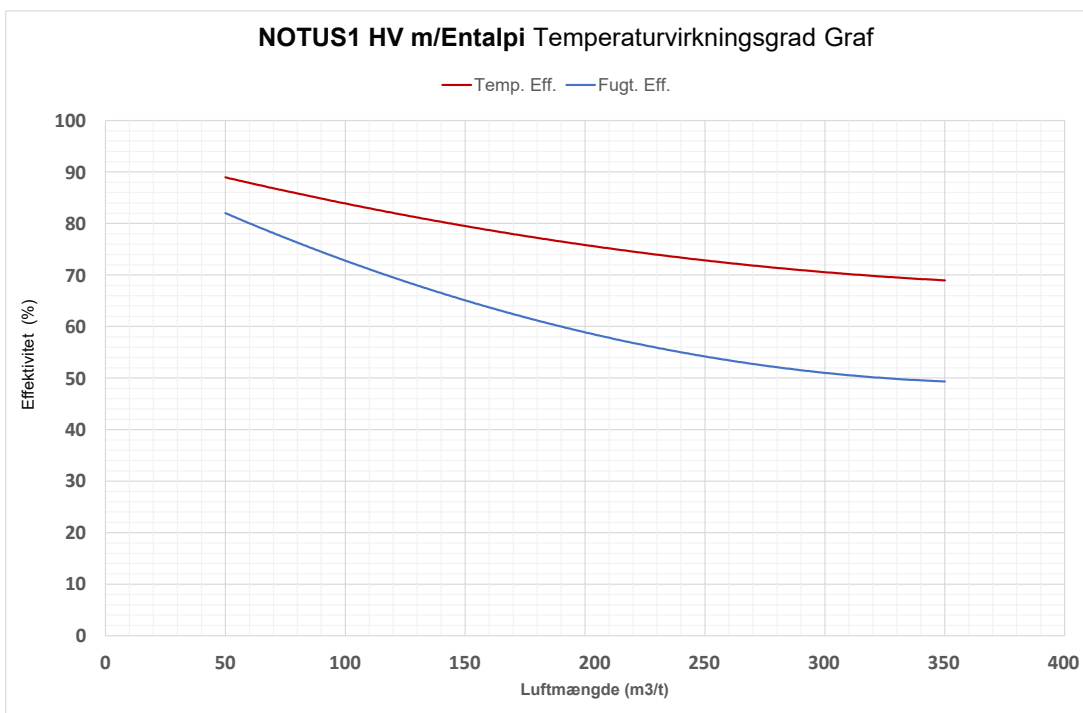

Tekniske data

NOTUS1 HV m/Entalpi, 415 m³/t

Lyddata (LwA)

Frekvens (Hz)	Lydeffektfrekvensniveauer (dB)				
	Indblæsning dB	Udsugning dB	Afkast dB	Indtag dB	Overflade dB
63	41,4	49,0	39,6	45,4	28,1
125	46,0	57,0	46,1	54,1	35,2
250	53,8	61,0	52,0	58,4	48,9
500	57,6	58,1	56,3	55,5	50,5
1000	54,5	60,2	52,2	56,5	48,8
2000	47,8	58,3	47,0	56,7	50,8
4000	42,2	56,0	40,1	52,5	45,2
8000	34,7	52,8	31,5	48,4	30,4
Total ±2	60,9	66,8	59,4	64,0	56,0
LpA	-	-	-	-	45,0



Lyddata er for $q_v = 375 \text{ m}^3/\text{h}$ og $P_{t \text{ ext}} = 100 \text{ Pa}$ iht. EN 3744 for overflade og EN 5136 for kanaler.

Lydeffektniveauet L_{WA} falder med faldende luftmængde og faldende modtryk.

Lydtryksniveauet L_{pA} i 1 m fra anlægget.

Lufttilslutninger

	INDTAG (udefra og ind i varmeveksler)
	UDSUGNING (fra bolig og ind i varmeveksler)
	INDBLÆSNING (fra varmeveksler og ind i bolig)
	AFKAST (fra varmeveksler til udenfor)

Vertikal Top In / Top Out Venstre
V-TITO-V

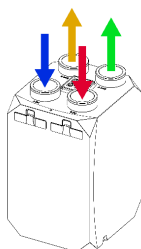

Vertikal Top In / Top Out Højre
V-TITO-H

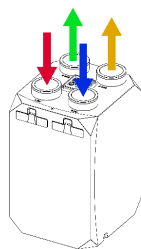

Horizontal Venstre In / Højre Out Top
H-VIHO-T

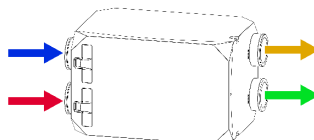

Horizontal Højre In / Venstre Out Top
H-HIVO-T

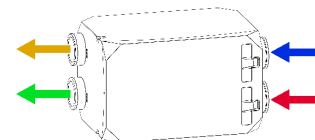

Vertikal Top In / Bund Out Venstre
V-TIBO-V

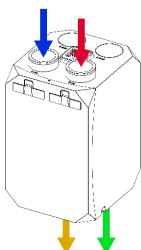

Vertikal Top In / Bund Out Højre
V-TIBO-H

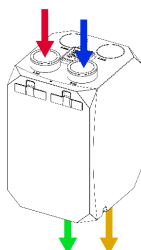

Horizontal Venstre In / Højre Out Bund
H-VIHO-B

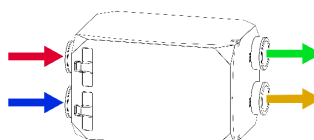

Horizontal Højre In / Venstre Out Bund
H-HIVO-B

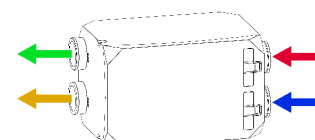

Tekniske data

NOTUS1 HV m/Entalpi, 415 m³/t

Mål/dimensioner (mm)

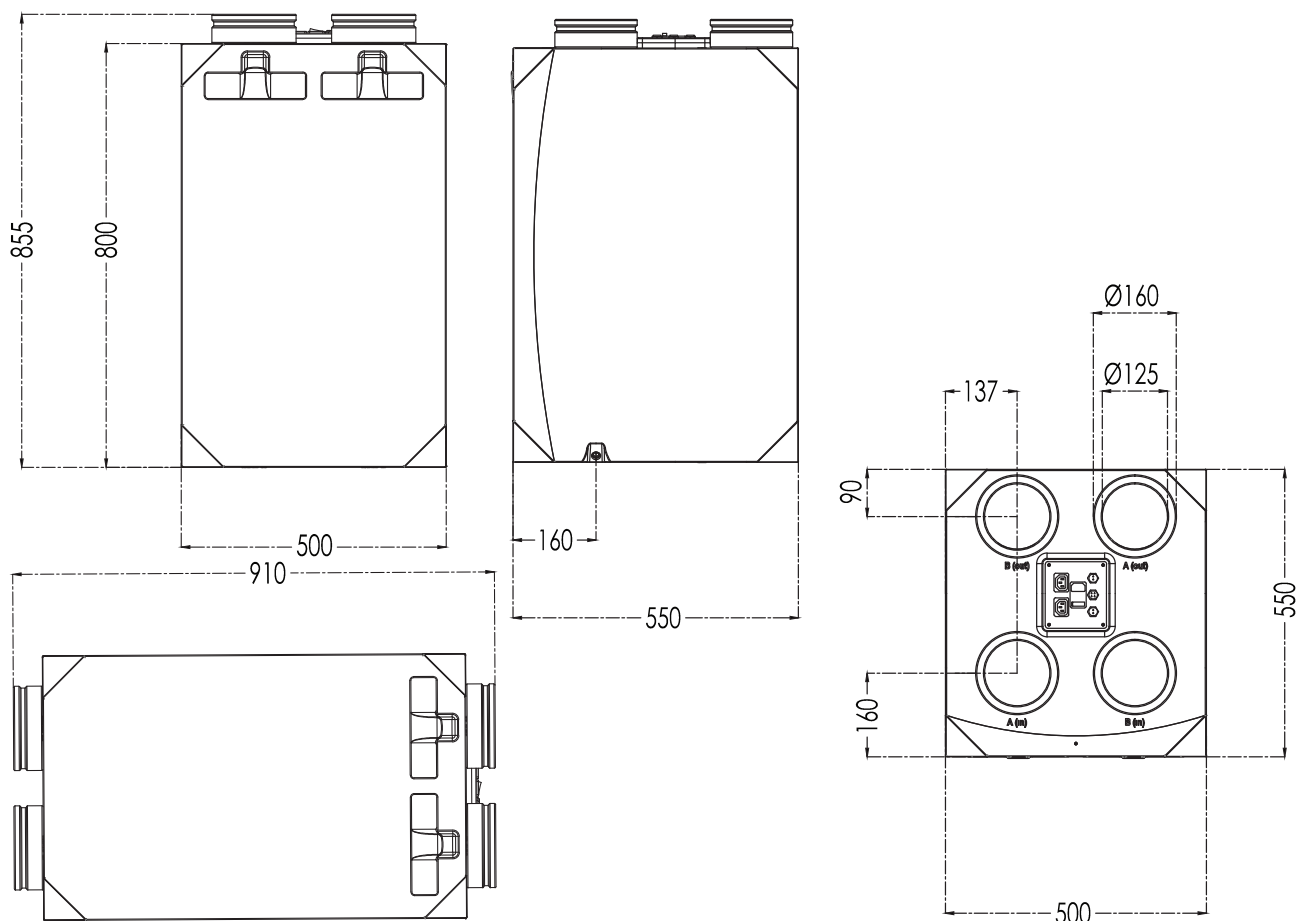

NOTUS1 HV Entalpi	
Energiklasse	A+
Max. luftstrøm (@100 Pa)	350 m ³ /h
Max. termisk effektivitet	87 %
Forsyningsspænding	230V AC 50Hz
Max. elektrisk effekt	150 W, 0.7 A
Kabinet materiale	Ekspanderet Polypropylen (EPP)
Dimensioner (LxWxH)	550x500x855 mm
Vægt	20 kg
Varmeveksler type	Entalpi (valgfri plast modstrøm)
Ventilator og Motor type	Baguddrejede ventilatorblade med EC motorer
Filterklasse	2 x G4 filter (valgfri F7)
Kanalforbindelser	begge Ø160 mm og Ø125 mm
Kondensafløb	Ø20 mm
Monteringsmuligheder	Horisontal (både venstre og højre) - Vertikal (både Top og Bund)
Driftstemperaturer	-25°C til +60°C

Tekniske data

NOTUS1 HV m/Entalpi, 415 m³/t

Se brugermanual på www.termicplus.dk

Brugermanual
på webside

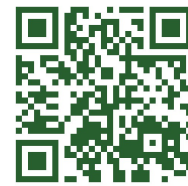

Scan koden med dit mobilkamera

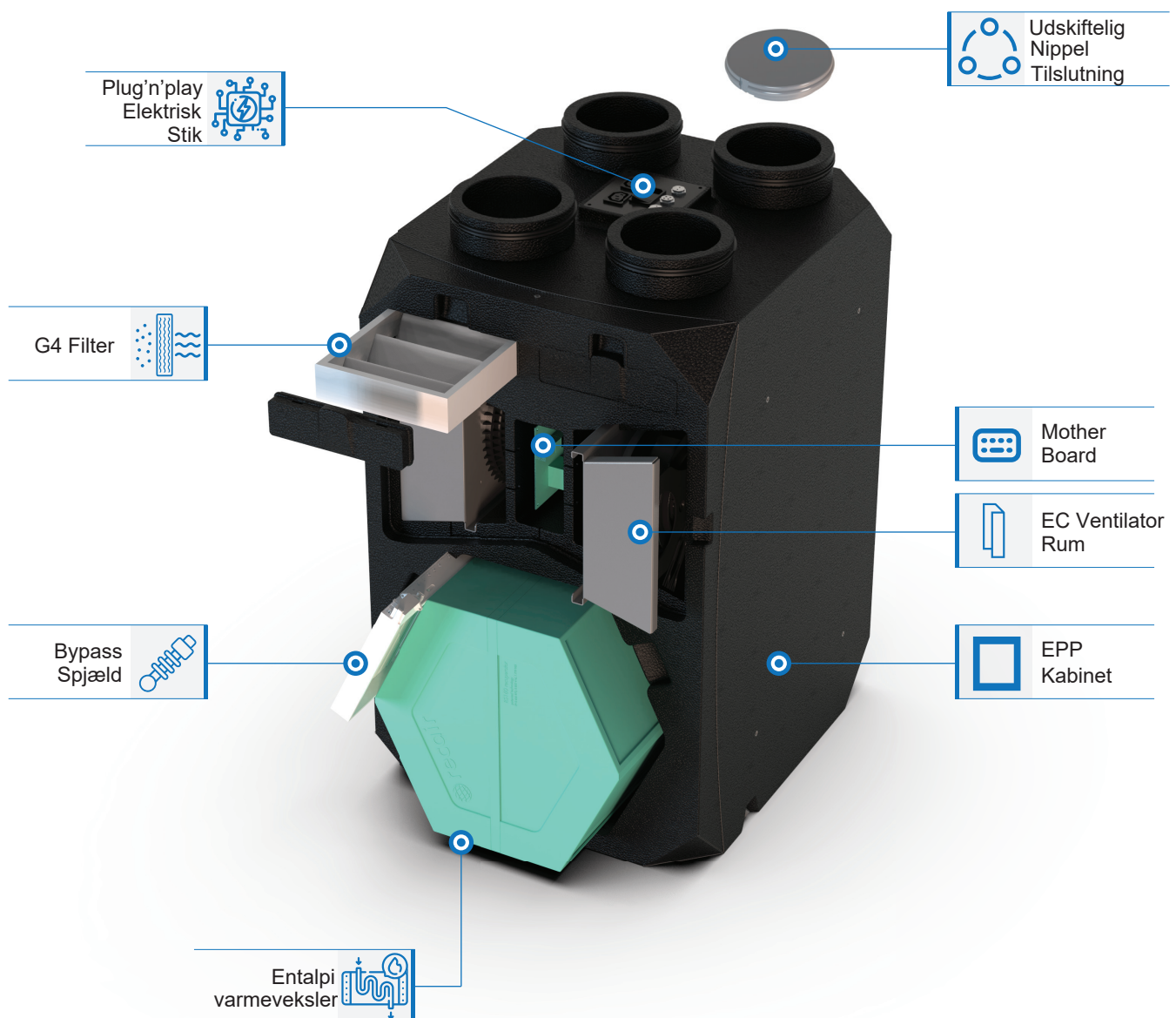

Tekniske data

NOTUS1 HV m/Entalpi, 415 m³/t

Certifikat



ATTESTATION OF CONFORMITY

UYGUNLUK ONAYI

Certificate Number <i>Sertifika Numarası</i>	: CAC-M-0017-2
Manufacturer <i>Üretici</i>	: BSK HAVALANDIRMA EKİPMANLARI A.Ş.
Manufacturer Adress <i>Üretici Adresi</i>	: MİMAR SİNAN MAH. BASRA CAD. NO 59 SULTANBEYLİ, İSTANBUL/ TÜRKİYE
Related Directives <i>İlgili direktifler</i>	: 2014/35/EU Electrical Equipment Designed For Use Within Certain Voltage Limits <i>2014/35/AB Belirli Gerilim Sınırları İçin Tasarlanan Elektrikli Ekipman İle İlgili Yönetmelik</i> 2014/30/EU Electromagnetic Compatibility Directive <i>2014/30/AB Elektromanyetik Uyumluluk Yönetmeliği</i>
Product Description <i>Ürün Tanımı</i>	: EPP Body Residential Heat Recovery Device <i>EPP Gövdeli Ev Tipi Isı Geri Kazanım Cihazı</i>
Type / Model <i>Tip / Model</i>	: BSK Notus
Related Standards <i>İlgili Standardlar</i>	: EN IEC 55014-1:2021, EN IEC 55014-2:2021, EN 60335-1:2012
Test Report <i>Test Raporu</i>	: 23-3596-R0-N1-1, 281223-1

CAC Conformity Assessment Center d.o.o. confirms by examining technical documents presented on the part of company which stated title and address below that product is conformable to 2014/35/EU Electrical Equipment Designed For Use Within Certain Voltage Limits regulations annex II, and 2014/30/EU Electromagnetic Compatibility Directive annex II, could attach CE marking on the product with EC Declaration of Conformity prepared by manufacturer in the charge of company. In case of changing this certificate design regarding to product examined, certificate will be expired. Please check validity of this certificate by website www.conasce.com This certificate is valid just for the product type/models stated below. CAC and Company above mentioned must retain a copy of these certificates for 15 years since the day of registration. This certificate property belongs to CAC Conformity Assessment Center d.o.o. and if required it must be returned.

CAC Conformity Assessment Center d.o.o. adı ve adresi yukarıda belirtilen firmanın sunduğu teknik dokümanları inceleyerek, belirlenen ürünün 2014/35/AB Belirli Gerilim Sınırları İçin Tasarlanan Elektrikli Ekipman İle İlgili Yönetmelik EK III kurallarına ve 2014/30/AB Elektromanyetik Uyumluluk Yönetmeliği EK II uygunluğunu onaylar. Yukarıda belirtilen tiplerdeki ürün üzerine CE işaretini, üreticinin kendi sorumluluğunda hazırlayacağı AT Uygunluk Beyanı ile iliştiirebilir. İncelemesi yapılan ürüne ait olan bu belge tasarımın değişmesi halinde geçerliliğini yitirecektir. Bu belgenin geçerliliğini www.conasce.com internet sayfasından kontrol edebilirsiniz. Bu belge sadece yukarıda adı geçen ürün tip/modelleri için geçerlidir. Yukarıda adı geçen firma ve CAC bu belgelerin bir kopyasını tescil tarihinden itibaren 15 yıl süreyle muhafaza etmelidir. Bu belgenin mülkiyet hakkı CAC Conformity Assessment Center d.o.o.'ya aittir ve istenildiğinde iade edilmelidir.

Issue date <i>Yayın tarihi</i>	: 18.01.2024
Re-issue date <i>Yeniden belgelendirme tarihi</i>	: -
Validity date <i>Geçerlilik tarihi</i>	: 17.01.2027





CAC Conformity Assessment Center d.o.o.
Radnička cesta 54/R3 10000 Zagreb Croatia
info@conasce.com +385 (1) 4819 601

Tekniske data

NOTUS1 HV m/Entalpi, 415 m³/t

Overensstemmelseserklæring/CE

DECLARATION OF CONFORMITY

UYGUNLUK BEYANI



Owner of Declaration <i>Deklarasyon Sahibi</i>	BSK Havalandırma Ekipmanları A.Ş. Mimar sinan mah. Basra cad. No 59 Sultanbeyli, İstanbul
Manufacturer <i>İmalatçı</i>	BSK Havalandırma Ekipmanları A.Ş. Mimar sinan mah. Basra cad. No 59 Sultanbeyli, İstanbul
Product: <i>Ürün:</i>	EPP Body Residential Heat Recovery Device <i>EPP Gövdeli Ev Tipi Isı Geri Kazanım Cihazı</i>
Type/Model <i>Tip Model</i>	BSK NOTUS
Trade Mark <i>Ticari Marka</i>	
Base of attestation: <i>Onay Dayanağı</i>	File Of Technical Documentation, Test Report , Operating Manual <i>Teknik Dosya, Test Raporu, Kullanma Kılavuzu</i>
Applied EC Directives <i>Uygulanan A. T. Yönetmelikleri</i>	2014/35/EU 2014/30/EU
Applied Standards: <i>Uygulanan Standartlar</i>	EN IEC 55014-1:2021, EN IEC 55014-2:2021, EN 60335-1:2012
Last Two Digit Year of CE Mark Affixed <i>CE İşaretinin İliştirildiği Yılın Son İki rakamı</i>	24

We " BSK Havalandırma Ekipmanları A.Ş. " hereby declare that specified above conforms covering European Parliament and Council Directives 2014/35/EU of 26 February 2014 Low Voltage Directive and 2014/30/EU of 26 February 2014 Electromagnetic Compatibility .

Biz " BSK Havalandırma Ekipmanları A.Ş. " olarak yukarıda belirtilen ürünümüzü Avrupa Topluluğu Yönetmelikleri 26 Şubat 2014 tarihli 2014/35/EU Alçak Gerilim Yönetmeliği ve 26 Şubat 2014 tarihli 2014/30/EU Elektromanyetik uyumluluk Yönetmeliği'ne göre uygun olduğunu beyan ederiz.

İstanbul , Türkiye
Date: 19.01.2024

General Manager

HAVALANDIRMA EKİPMANLARI A.Ş.
Mimar Sinan Mah. Basra Cad. No:59/A
Sultanbeyli / İstanbul
Tel: 0216 659 09 70 (pbx) FAKS: 0216 669 09 72
Sultanbeyli V.D. / 397 050 3997

Alle anførte tekniske data er baseret på producentens nuværende viden.
Der tages forbehold for ændringer og evt. trykfejl.

16.10.2024