

TriaAir fordelerboks

Ø160 nippel – 5 muffler Ø75

Varenr. MC75B05160

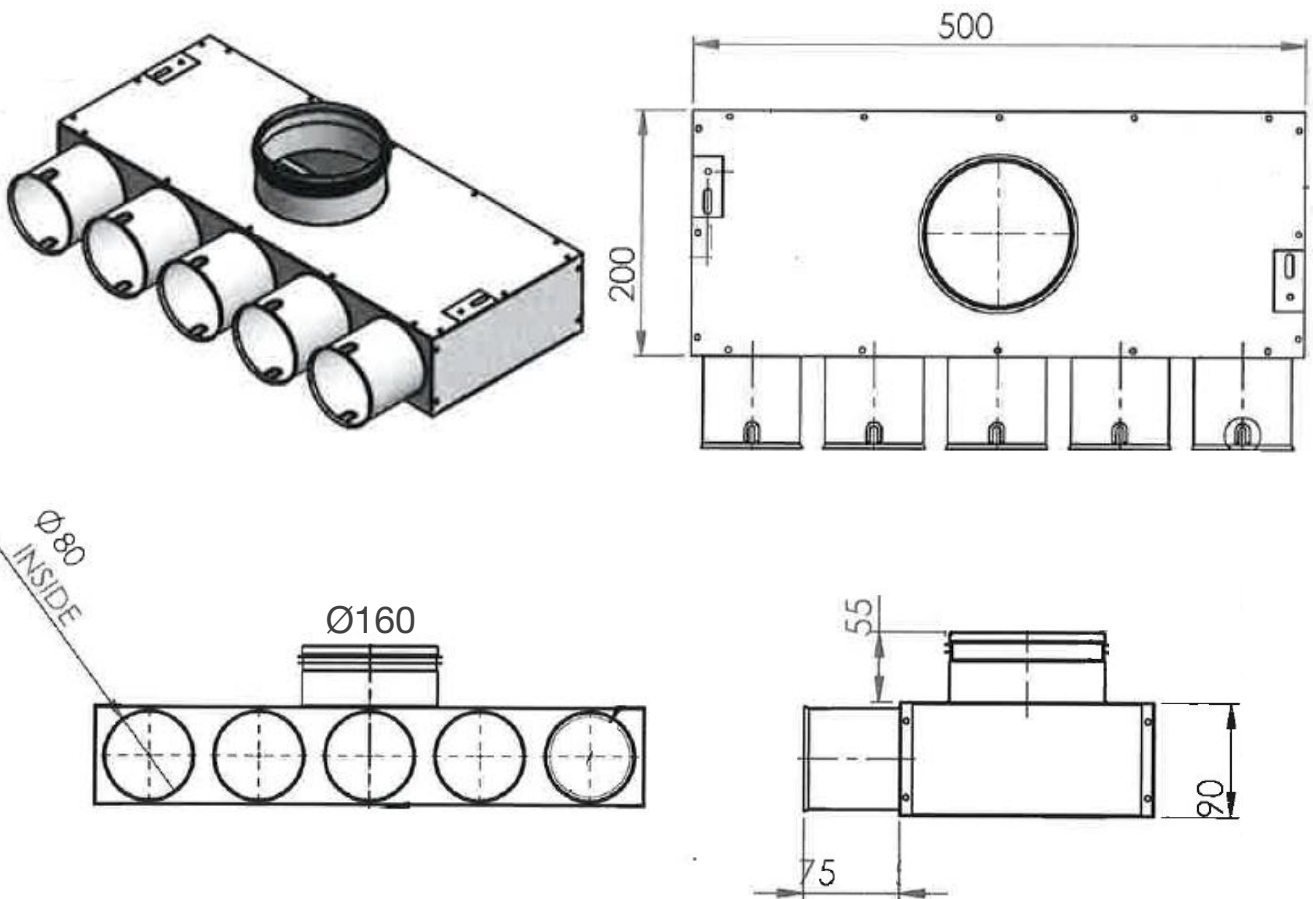

Flowdiagram

MC75B05160	
Flow Rate [m ³ /h]	Resistance [Pa]
40	0,7
55	1,1
75	1,4
110	2,7

